

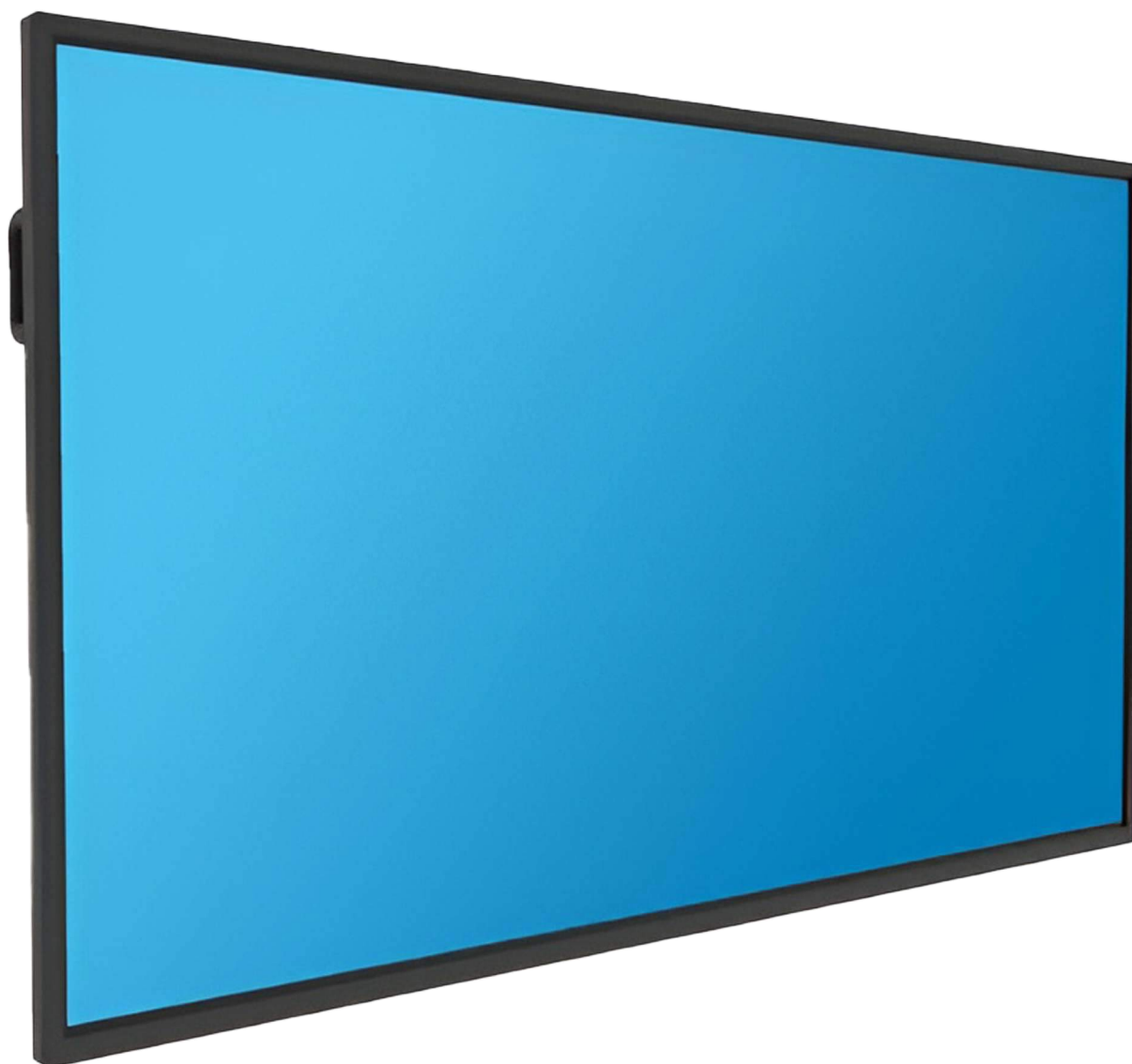

[promultis]

Lightning IV Screen



User Manual

Before connecting, operating or adjusting this product, please read the manual completely.

Please keep this manual for future reference.

CONTENTS

Important Information	1
Important Safety Precautions	2
Identification of Controls	4
Remote Control	6
Connections	7
Basic Operations	9
Operating the Side Menu	10
User Menu List	11
Annotation	16
WhiteBoard	17
USB multi media player	18
Troubleshooting	19
Specifications	20

IMPORTANT INFORMATION

If the screen is not positioned in a stable location, it can be potentially hazardous due to falling. Many injuries, particularly to children, can be avoided by taking simple precautions such as:

- Use cabinets or stands recommended by the manufacturer of the screen.
- Only use furniture that can safely support the screen.
- Ensure the screen is not hanging over the edge of the supporting furniture.
- Do not place the screen on tall furniture (for example, cupboards or bookcases) without anchoring both the furniture and the screen to a suitable support.
- Do not position the screen on cloth or place any material between the screen and supporting furniture.
- Increase children's awareness of danger caused by falling down of the screen, or being hurt by bumping into the screen.
- Do not use immediately after moving from a low temperature to high temperature environment, as this causes condensation, which may result in fire, electric shock, or other hazards.
- To avoid possible condensation it is recommended to not use the device within 24 hours after its arrival, to avoid possible condensation.

Warning:

To prevent the spread of fire, keep candles or other open flames away from the screen the times.

IMPORTANT SAFETY PRECAUTIONS



This symbol indicates that dangerous voltage instituting a risk of electric shock is present within this unit.



This symbol indicates that there are important operation and maintenance instructions in the literature accompanying the appliance.

Electricity may cause personal injuries and property damage if handled improperly. The screen has been engineered and manufactured with the highest priority on safety. But IMPROPER USE CAN RESULT IN POTENTIAL ELECTRIC SHOCK OR FIRE HAZARD. In order to prevent potential danger, please observe the following instructions when installing, operating and cleaning the product. To ensure your safety and prolong the service life of your screen, please read the following precautions carefully before using the product.

- 1. Read these instructions**---All operating instructions must be read and understood before the product is used.
- 2. Keep these instructions**---These safety and operating instructions must be kept in a safe place for future reference.
- 3. Note all warnings**---All warnings on the product and in the instruction manual must be observed closely.
- 4. Follow all instructions**---All operating instructions must be followed.
- 5. Attachments**---Only use attachments/accessories specified by the manufacturer. Do not use attachments which are not recommended by the manufacturer. Use of improper attachments can result in accidents.
- 6. Power source**---This product is intended to be supplied with a listed power supply indicated on the marking label. If you are not sure of the type of power supply at your location, consult your product dealer or local power company. For added protection for this product during a lightning storm, or when it is left unattended and unused for a long period of time, unplug it from the wall outlet and disconnect the cable system.
- 7. Power cord protection**---Protect the power cord from being walked on or pinched particularly at plugs, wall outlet, and the point where they exit from the device.

NOTE: Where the mains plug or an appliance coupler is used as the disconnected device, the disconnected device shall remain readily operable.

- 8. Overloading**---Do not overload wall outlets, extension cords, or convenience receptacles on other equipment as this can result in a risk of fire or electric shock.
- 9. Entering of objects and liquids**---Never insert an object into the product through vents or openings. High voltages are present in the product and inserting an object can cause electric shock and/or short circuit internal parts. For the same reason, do not spill water or liquid on the product.

10. Servicing---Refer all servicing to qualified service personnel. Servicing is required when the device has been damaged in any way, such as the power-supply cord or plug is damaged, liquid has been spilled, objects have fallen into the device, the device has been exposed to rain or moisture, does not operate normally or has been dropped.

11. Damage requiring service---If any of the following conditions occurs, unplug the power cord from the AC outlet and request a qualified service technician to perform repairs.

- When the power cord or plug is damaged.
- When liquid is spilled on the product or when objects have fallen into the product.
- When the product has been exposed to rain or water.
- When the product does not operate properly as described in the operating instructions.

Do not touch the controls other than those described in the operating instructions. Improper adjustment of controls not described in the instructions can cause damage, which often requires extensive adjustment work by a qualified technician.

- If the product has been dropped or the cabinet has been damaged in any way.
- When the product displays an abnormal condition or exhibits a distinct change in performance. Any noticeable abnormality in the product indicates that the product needs servicing.

12. Replacement parts---In case the product needs replacement parts, make sure that the service person uses replacement parts specified by the manufacturer, or those with the same characteristics and performance as the original parts. Use of unauthorized parts can result in fire, electric shock and/or other danger.

13. Safety checks---Upon completion of service or repair work, request the service technician to perform safety checks to ensure that the product is in proper operating condition.

14. Wall or ceiling mounting---When mounting the device on a wall or ceiling, be sure to install the product according to the method recommended by the manufacturer. This is a safety issue.

15. Stand---Use only with the trolley, stand or wall mount specified through CE/UL/GS safety certificate. or sold with the device. Do not place the product on an unstable trolley, stand. Placing the product on an unstable base can cause the product to fall, resulting in possible serious injuries as well as damage to the device.

16. Careful move---When a trolley is used, be cautious when moving the trolley/device combination to avoid injury from the device tipping over. Sudden stops, excessive force and uneven floor surfaces can cause the product to fall from the trolley.

Careful move and be careful please, point of strength should not in display screen.

Never attempt to move the screen unless the AC power cord has been disconnected.

17. Do not use this device near water---for example, near a bathtub, washbowl, kitchen sink, laundry tub, in a wet basement or near a swimming pool, and the like.

IMPORTANT SAFETY PRECAUTIONS

The apparatus should not be exposed to dripping or splashing liquids and that no objects filled with liquids, such as vases, shall be placed on the apparatus.

Do not use immediately after moving from a low temperature to high temperature environment, as this causes condensation, which may result in fire, electric shock, or other hazards.

18.Clean only with dry cloth---Unplug the device from the power before cleaning. Do not use liquid cleaners or aerosol cleaners. Use a soft cloth for cleaning.

19.Ventilation---Do not block any ventilation openings. Install the screen in accordance with the manufacturer instructions. Do not cover or block these vents and openings since insufficient ventilation can cause overheating and/or shorten the life of the product. This product is not designed for built-in installation; therefore do not place the product in an enclosed space such as a bookcase or rack, unless proper ventilation is provided or the manufacturer's instructions are followed.

It should have interspace around the product and the wider it has the heat dissipation is better. Suggest up>10cm, around>10cm and back >2.5cm.

20.Heat sources---Do not install near any heat sources such as radiators, heat registers, stoves, or other device (including amplifiers) that produce heat.

21.Panel protection---The display panel used in this product is made of glass. Therefore, it can break when the product is dropped or impacted upon by other objects. Be careful not to be injured by broken glass pieces in case the display panel breaks.

Do not use hard or sharp object to take place of special pen when write in the screen.

Wipe the screen from one side to the other carefully till it looks completely clean. Do not flailing in all directions.

22.Pixel defect---The display panel is a very high technology product, giving you fine detailed pictures. Occasionally, a few non-active pixels may appear on the screen as a fixed point of blue, green or red. Please note that this does not affect the performance of your product.

WARNING: For continued safety, device with class I construction shall be connected to a mains socket outlet with a protective earthing connection.

Environmental Protection

Waste electrical products should not be disposed of with household waste. Please recycle where facilities exist. Check with your Local Authority or retailer for recycling advice.



About Location/Environment

Do not use in hot and cold rooms (locations)

- When the unit is used in rooms (locations) with low temperature, the picture may leave trails or appear slightly delayed. This is not a malfunction. The unit will recover when the temperature returns to normal.
- Do not leave the unit in a hot or cold location. Also, do not leave the unit in a location exposed to direct sunlight to near a heater or in high humidity, as this may cause the cabinet to deform and the screen to malfunction and affect the screen's performance.
- Environment condition:
Operating temperature: 5°C – 35°C
Operating humidity: 20% – 80% (no moisture condensation)
Storage temperature: -15°C – 45°C
Storage humidity: 10% – 80%
Atmospheric pressure: 86 kPa ~106 kPa

About After-Image

The extended use of fixed image program material can cause a permanent after-image on the screen.

This background image is viewable on normal programs in the form of a stationary fixed image. This type of irreversible screen deterioration can be limited by observing the following steps:

- Reduce the brightness/contrast setting to a minimum viewing level.
- Do not display the fixed image for extended periods of time.
- Turn the power off when the display is not in actual use.

Important Information Regarding Use of Video Games, Computers, Captions or Other Fixed Image Displays.

- Do not allow a still picture to be displayed for an extended period of time, as this can cause a permanent after-image to remain on the screen. Examples of still pictures include logos, video games, computer images, teletext and images displayed in 4:3 mode.

CAUTIONS:

- The permanent after-image on the screen resulting from fixed image use is not an operating defect and as such is not covered by the warranty.
- This product is not designed to display fixed images for extended periods of time.
- It is not advised to put the screen in portrait mode because this will affect the warranty.

Cleaning and Maintenance

To clean this unit, wipe with a soft, dry cloth.

Clean the cabinet with a soft, lint-free cloth. If the cabinet is especially dirty, moisten a soft, lint-free cloth in a weak detergent Solution, squeeze the excess moisture from the cloth, then wipe the cabinet with the cloth. Use a clean cloth to dry the cabinet.

- Use eyeglass cleaner to remove stubborn dirt from the screen.
- Never use alcohol, paint thinner or benzene to clean this device.

Carrying or Moving the screen

- When you move the screen, hold the frame of the screen.
- Be aware of the danger or harm which may be caused by carrying or moving the screen, as the bezel is very thin.
- When transporting, do not subject the unit to shocks or vibration, or excessive force.

IDENTIFICATION OF CONTROLS

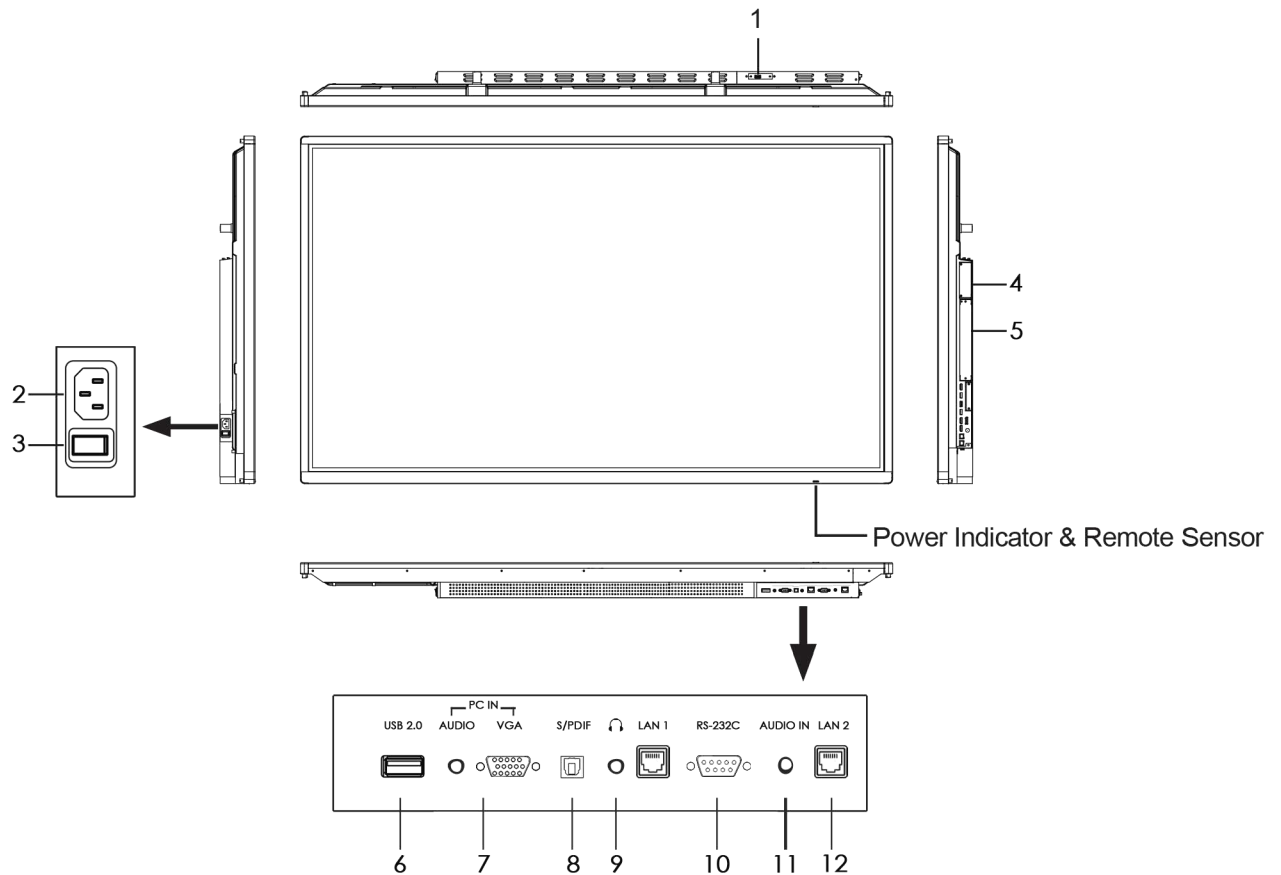

1	USB(3.0)(for camera)	Connect USB devices to this port for OPS or Android. Notes: Please open the dust cover before being used.
2	AC IN	Plug the AC cord into this jack and into a power outlet. (AC 100-240V 50/60Hz)
3	Power Switch	Push (I) to connect the power, push (O) to cut off the power. Note: Don't cover the power switch.
4	Extension module Slot	Insert an extension module (Optional).
5	OPS module slot	Insert an OPS module (Optional).
6	USB 2.0	Connect USB devices to this port.
7	PC IN	Connect the video/audio of a computer to these ports.
8	S/PDIF	Connect a digital sound system to this jack
9		Connect headphones to this jack. The monitor is the current audio output.
10	RS-232	For remote control, service and other uses.
11	AUDIO IN	Connect to the displays audio.
12	LAN IN 1/2	Connects the external network or the router.

IDENTIFICATION OF CONTROLS

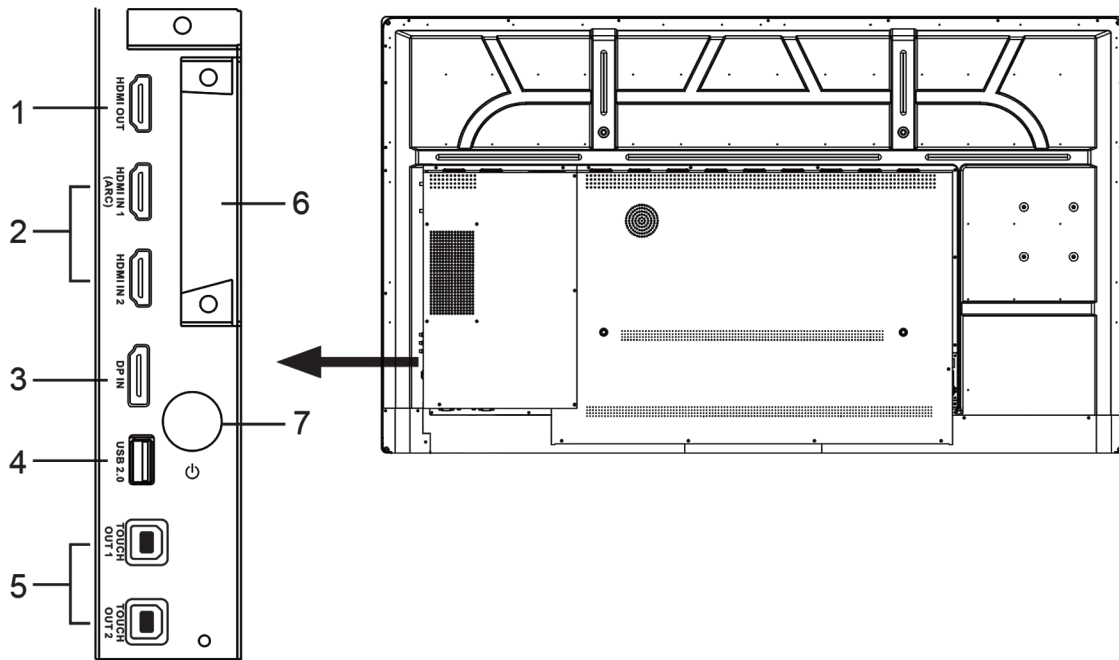

1	HDMI OUT	Connect a monitor to this port, output of the currently screen.
2	HDMI IN 1/2	Connect an HDMI or DVI device to this jack. HDMI IN 1(ARC): Connect an ARC-enabled home theater receiver to this jack.
3	DP(DisplayPort) INPUT	Connect an external device to DP out jack.
4	USB 2.0	Connect USB devices to this port for Android.
5	TOUCH OUT 1/2	Connect an external device to support touch control of the external device on the screen. Note: Touch out 1 corresponds to the HDMI 1, Touch out 2 corresponds to the HDMI 2, DP or VGA.
6	WiFi module slot	Insert a WiFi module.
7		Switches the screen power on or standby.

REMOTE CONTROL

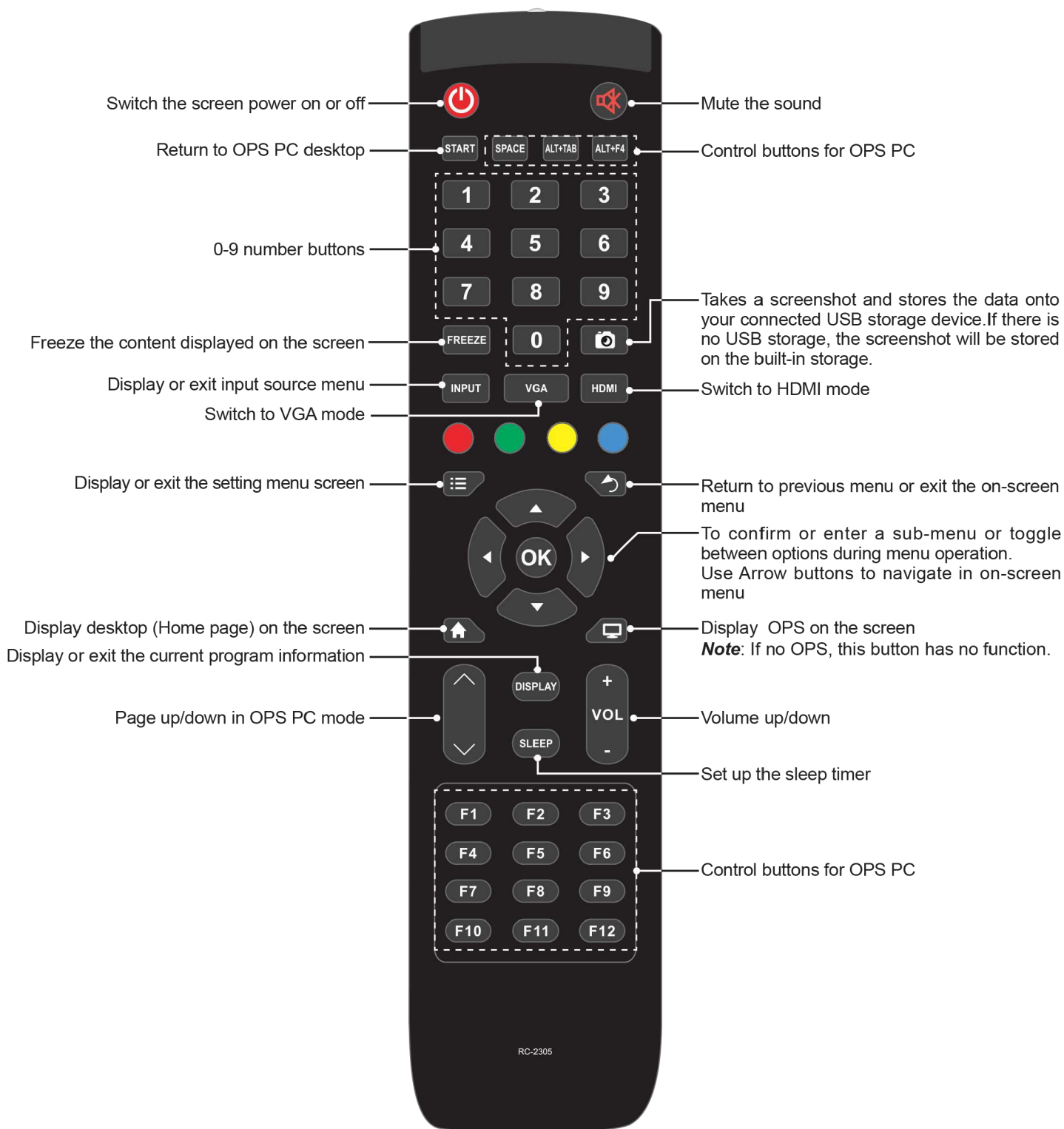

NOTES:

- This operation manual provides a description based on operating functions with the remote control.
- In different mode, some buttons may have different function.

CONNECTIONS

Cautions Before Connecting

- When connecting an external device to the screen, make sure that the screen and the external device are turned off.
- Check the plugs at the ends of the cables to make sure that they are the correct type before plugging them into the jacks on the screen.
- Make sure that all plugs are securely inserted into the jacks. Loose connections can result in image or color problems.
- The illustration of the external device may be different depending on your model.
- Refer to the operating manual of the external device as well.

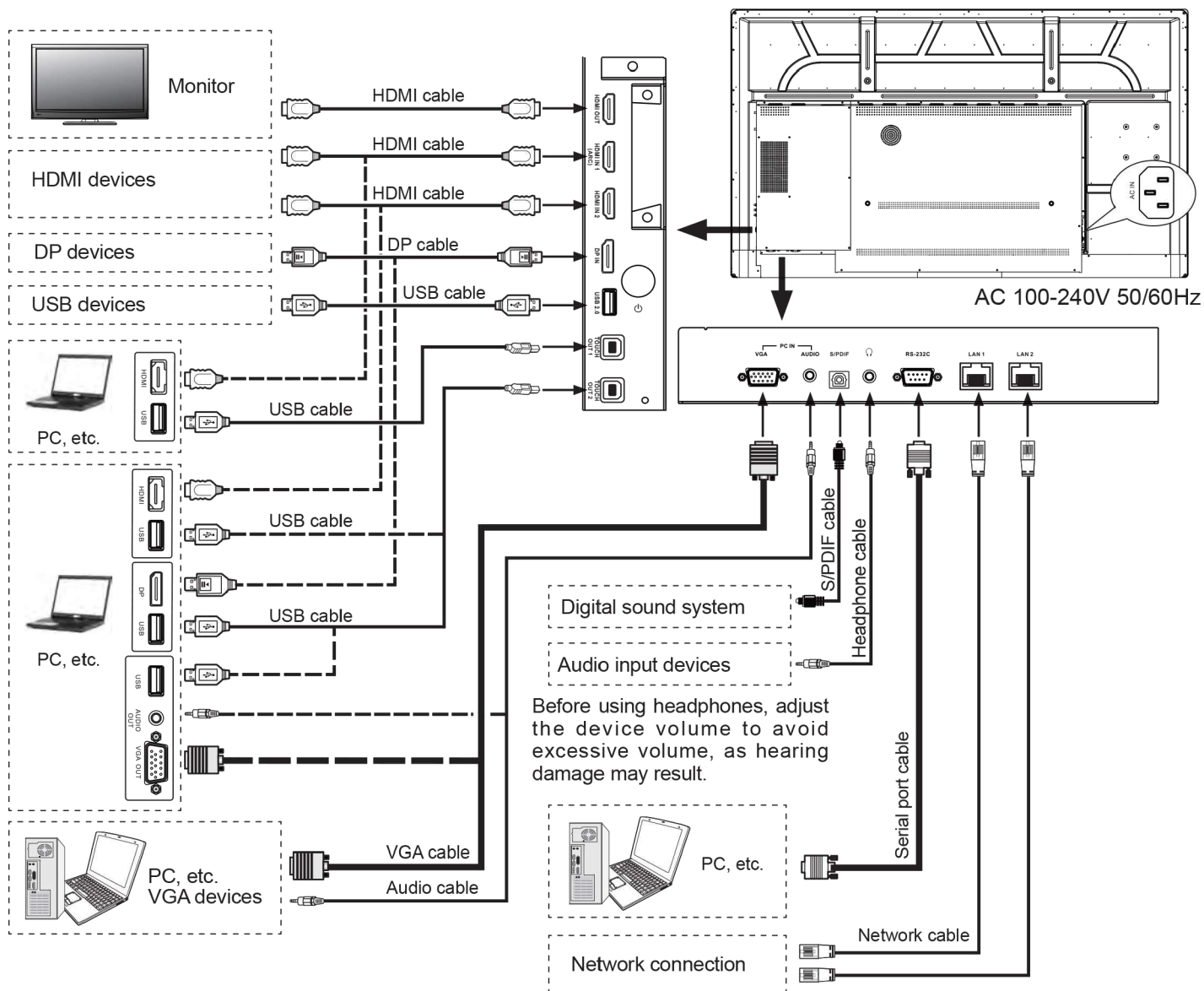

Connect TOUCH OUT with USB cable to PC USB port.

Connect PC with VGA cable, HDMI cable or DP cable. Please choose the proper method of connection based on your device. (Only for PC, HDMI, DP signal)

Touch out 1 corresponds to the HDMI 1, Touch out 2 corresponds to the HDMI 2, DP or VGA.

Note: After installation of the driver, it can control the external computer by native touch control.

OPERATING THE SIDE MENU

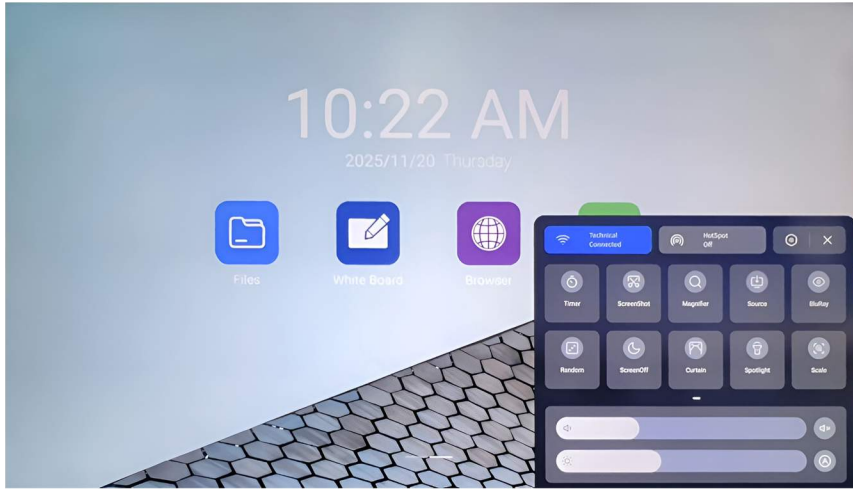

















How to reveal the side menu

Swipe up from the left-bottom or the right-bottom of the screen to reveal the side menu.

How to close the side menu

Tap anywhere on the screen to close the side menu.

 Wireless Network Setting Switches the device's WiFi connection on or off.	 Hotspot Switches the device's hotspot feature on or off.	 Settings	 Close Closes the side menu.	
 Timer For setting countdowns or on screen timers.	 ScreenShot Takes a screenshot of the current screen.	 Magnifer For zooming in on screen content.	 Source Opens the input menu for switching sources.	 BluRay Reduces blue light to ease eye strain.
 Random Generates random numbers within a range.	 ScreenOff Turns the display off.	 Curtain Mode For hiding content on the screen.	 Spotlight Highlights content on the screen.	 Scale Adjusts the screens zoom level.
 Volume Adjusts the systems volume				
 Display Brightness Adjusts the screens brightness				

BASIC OPERATIONS

Turning the screen on or off

1. Plug the power cord into an AC power outlet.
2. Press Power Switch on the screen.
3. Now the screen is in standby mode. Wait a moment until the power indicator lights up, then press  button to turn on the screen.

Note: Be sure to wait for a few seconds before pressing  button. If you promptly press  button then the screen may not respond or act wrongly.

4. Press  button again to turn off the screen and put the display in standby mode.
5. To cut off the power completely, press Power Switch on the back of the screen.

FIRST TIME INSTALLATION

When turning on the screen for the first time, the below shown installation menu pages will appear on the screen.

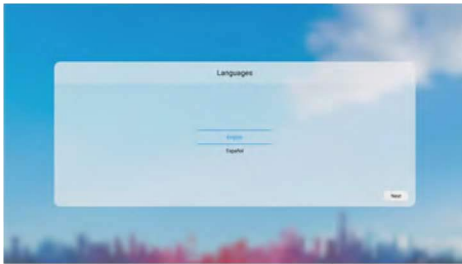

Select the desired menu language.
Press **Next** to go to the next page.

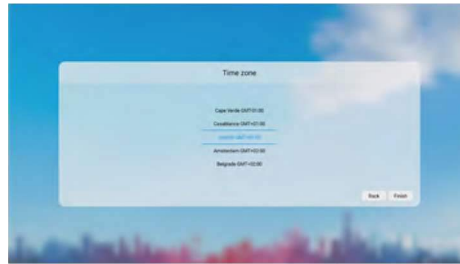

Select your Time Zone and press
Finish to finish the installation.

USER MENU LIST

1. NETWORK & CONNECTED DEVICES

Ethernet: Plug the LAN-cable into the LAN-port on the bottom of the monitor, the monitor will get an IP address automatically and connect to the internet.

WiFi: Turn the WiFi on. Select the network from WLAN network list to connect it.

Note: Once the device is connected to the WLAN network successfully then whenever the network is available, the device will be reconnected to the network without entering the password.

Portable hotspot: Setting Portable WiFi hotspot.

Bluetooth: Automatic search for Bluetooth devices.

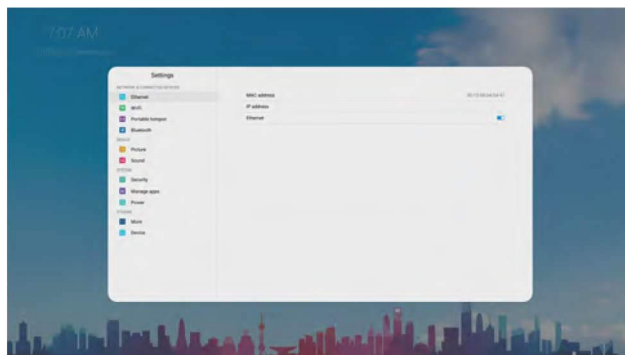

2. DEVICE

2.1 Picture: Adjusting picture.

Picture	Picture mode	Select picture mode. If you select "User", you can set the level of the Contrast, Brightness, Saturation, Sharpness as you desire.
	Energy saving mode	The backlight brightness is decreased.
	Color temperature	Select the color temperature.
	Eye protect	The backlight brightness is decreased automatically after writing for 3 seconds to protect eyesight. If it had not any writing, the backlight brightness will be returned to before it after about 10 seconds.
	Anti blue light	Turn on to decrease blue light to protect eyesight.
	Backlight	Set up the overall brilliance of the monitor.
Advanced	Contrast	Adjust the contrast.
	Brightness	Adjust the brightness.
	Saturation	Adjust the color saturation.
	Sharpness	Adjust the sharpness.
	PC mode	Select PC mode. (PC, Video)
	Display mode	Select the aspect ratio (display proportions).
	MEMC	Frame rate up conversion.(Only for 4K model)
	Overscan	Turn on or off.
	HDR	Turn on or off the High-Dynamic Range. It can provide more dynamic range and image details.
	VGA auto adjust	Automatically adjust the image settings such as position and phase.

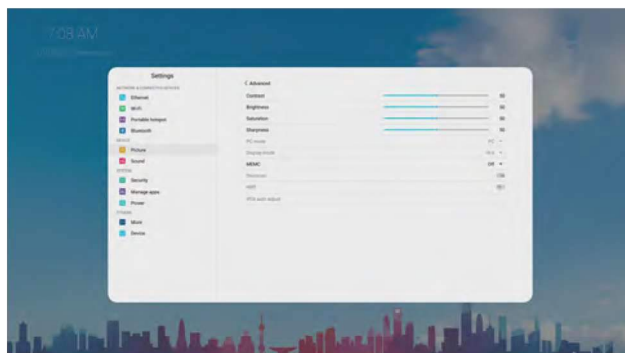
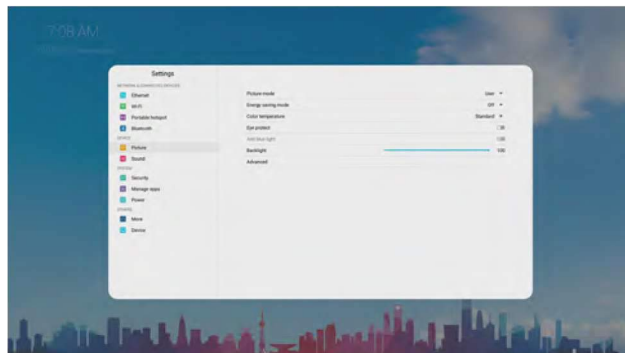

USER MENU LIST

2.2 Sound: Adjusting sound.

Sound	Media out device	Selection of Media out device.
	Sound mode	Select sound mode. If you select "User", you can set the level of the frequency response as you desire.
	SPDIF mode	Select the digital audio output mode for SPDIF . Select "RAW" to output audio signal as its original format. Select "PCM" to output audio signal by PCM format.
	AVC	Select "On" to equalize overall volume levels across all channels.
	Sound Effect	Turn the surround sound effect on or off.
	Volume	Adjust volume.
	Balance	Adjust volume level of right and left speakers.

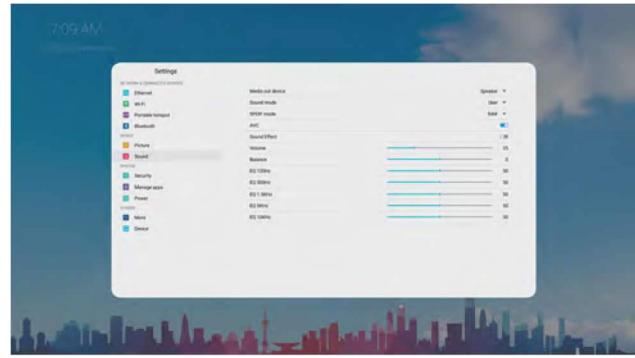

3. SYSTEM

3.1 Security

Change password: Password settings.

App lock: In order to lock the App.

App install lock: In order to lock the App install.

Touch lock: To disable the function of the touch panel.

Keypad lock: In order to lock the monitor buttons.

IR lock: To disable the function of the remote. (Except  button)

Network lock: To disable the function of the network.

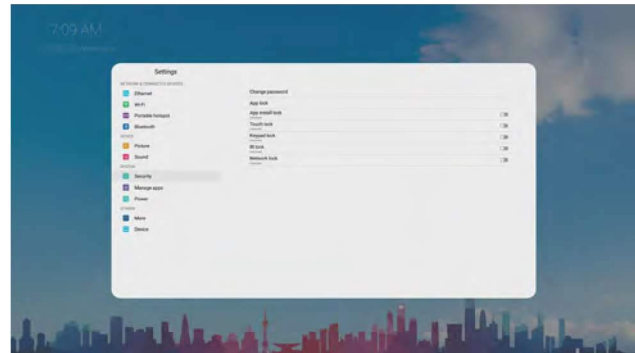

3.2 Manage apps

Installed apps: Displays the list of installed app.

All apps: Display all apps.

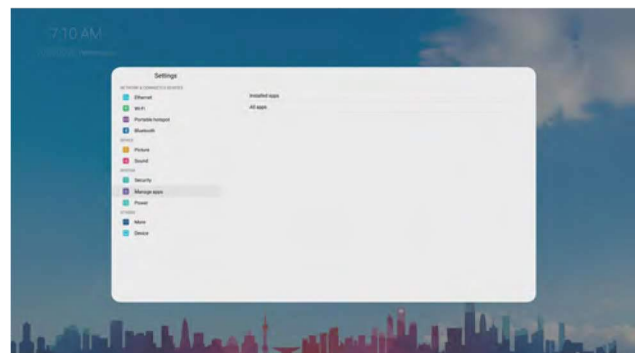

USER MENU LIST

3.3 Power

Timing power on/off

Timing off: To switch the monitor to standby at a specified time.

Timing on: To turn on the monitor automatically to source at a certain time.

Power on settings:

Power on settings	Power on mode	Select power on mode.
	Power on Source	In Memory mode, when the monitor is turned on, it will automatically switch to the source where it powered off last time. Otherwise, it is in setting mode.
	Power on Volume	Select Memory mode, the power on volume will same as the turn off.
	Volume Settings	Select User mode, the power on volume is the value of this setting.
	Boot OPS when Power on	Turn on or off.

Wake on lan: Turn on or off the wake on lan function.

Sleep timer: Set the duration of time until the monitor automatically goes into Standby mode.

Auto sleep: Auto Sleep will bring the monitor to standby automatically when there is no signal input for a certain time.

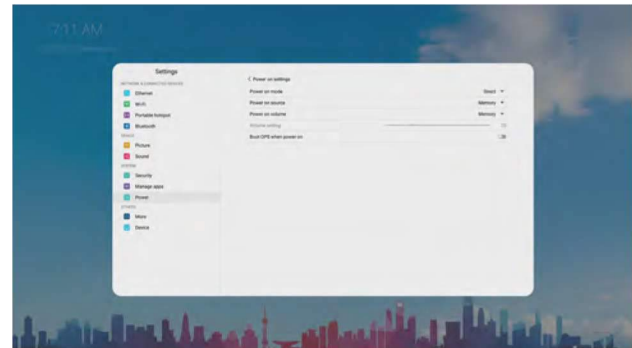
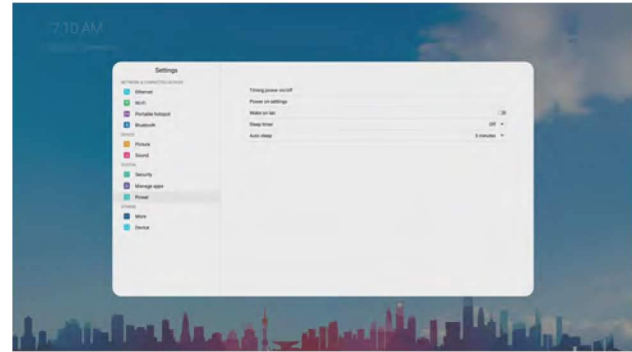

4. OTHERS

4.1 More

Auto source switch: Select On to automatically recognition source (Prompt, Direct).

Temperature protection: Turn on or off the temperature protection function.

Current temperature: Showing the present temperature value of the monitor.

Alarm temperature: Setting alarm temperature.

Note: When the temperature protection is turned on, if the current temperature exceeds the alarm temperature, the countdown is on for the monitor turn off. If you want to cancel shutdown can be canceled within 30 seconds.

HDMI

HDMI out: Select HDMI output resolution.

HDMI EDID version: Select HDMI EDID Ver.

Date & time: To manually set date and time, you should toggle "Automatic date & time" to OFF.

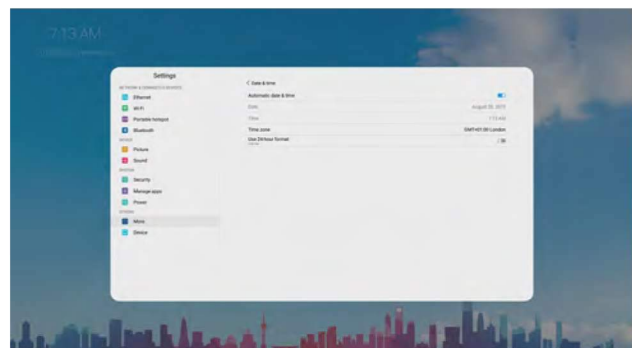
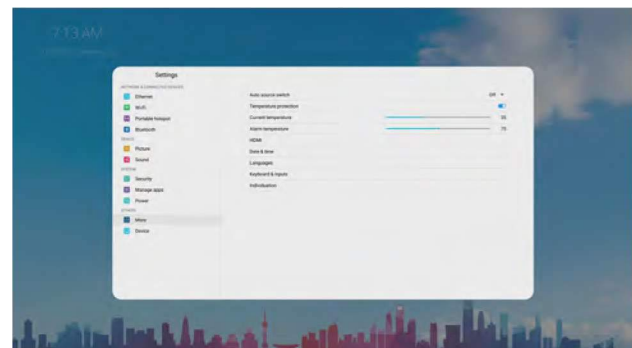

USER MENU LIST

Languages: Select menu language.

Keyboard & inputs: Setting input method.

Individuation: Turn on or off the **Fullscreen gesture** function.
Setting **wallpaper**, **no input wallpaper**, **source label**.

Note: When the fullscreen gesture is turned off, swipe up from the bottom of the screen to call only the side menu.

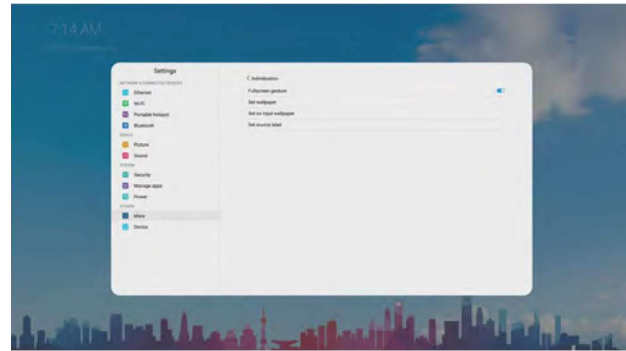

4.2 Device:

It displays the following information:

Device name

Device model

System information: Display system information.

System updates: Local update, Online update.

Reset: Reset all settings to factory defaults.

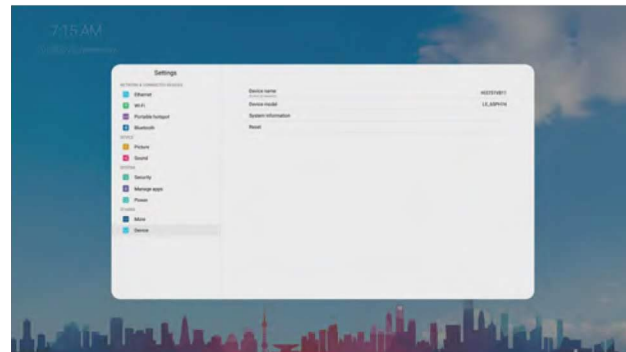

ANNOTATION

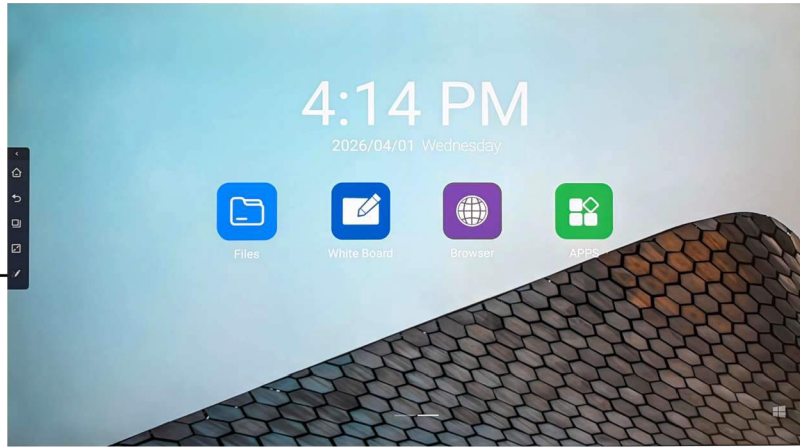

Annotation

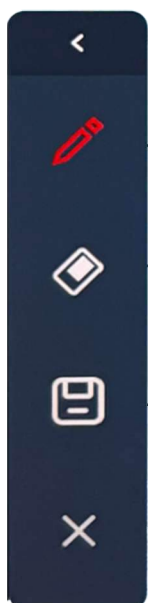
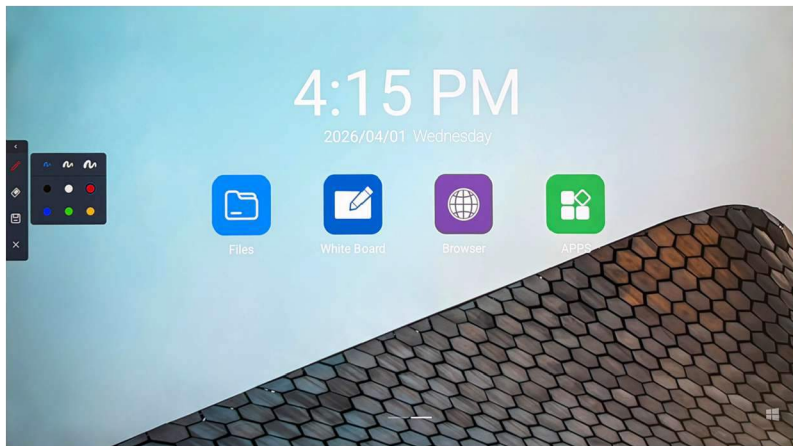

Pen: Click to choose a color of the pen.

Eraser: Click to choose a size of the eraser.

Screenshot: Click to capture the current screen.

Exit: Click to exit the annotation.

WHITEBOARD

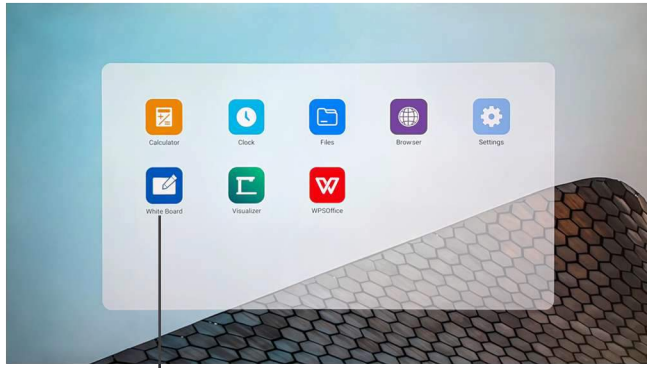

White Board application



Menu

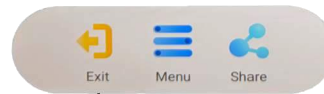
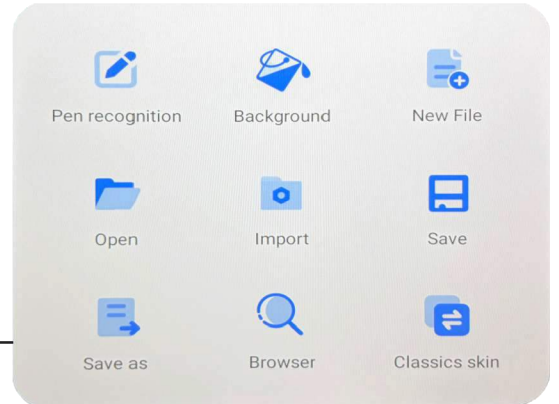

Click to exit the White Board application



Add page & page number

Tool bar

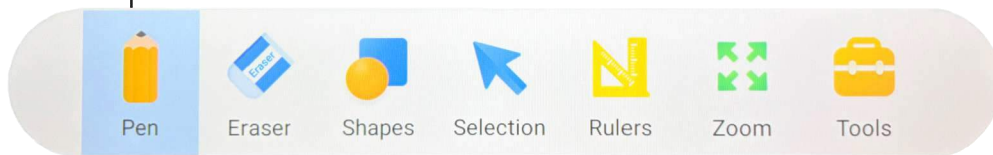

TROUBLESHOOTING

If, after reading these operating instructions, you have additional questions related to the use of your screen, please call the services center in your local area.

Before calling service, please check the symptoms and follow suggested solutions.

Remote Control

Problem	Possible Solutions
Remote control does not operate	<ul style="list-style-type: none">● Make sure the power cord is plugged in.● Check the orientation of the batteries.● The batteries could be weak. Replace the batteries.

Video and Audio

Problem	Possible Solutions
No picture (screen not lit) but no sound	<ul style="list-style-type: none">● Make sure the power cord is plugged in.● Press POWER on the Screen or on the remote control.● Test another source.
Dark, poor or no picture (Screen lit) but good sound	<ul style="list-style-type: none">● Select a proper picture mode.● Adjust the brightness in the video setting.● Test another source.
No color, dark picture or abnormal color	<ul style="list-style-type: none">● Adjust the color saturation in the video setting.
Good picture but no sound	<ul style="list-style-type: none">● The sound may be muted. Press MUTE again to cancel.● Verify if sound should output and/or test another source.
Audio noise	<ul style="list-style-type: none">● Communication problems may occur if infrared communication equipment (e.g., infrared cordless headphones) is used near the screen. Move the infrared communication equipment away from the screen until the noise is eliminated.

General

Problem	Possible Solutions
Some items can not be accessed	<ul style="list-style-type: none">● If a setting option appears in gray, this indicates that the settings option is unavailable in current input mode. Some display menu items may be different when the unit works in different sources.
Remote control command is not working in some cases	<ul style="list-style-type: none">● During the timing of USB device detection (i.e. when the screen is turned on with USB device connected, or when you plug in USB device during the working of the screen), the display may not react on remote control buttons in such case. Wait a moment before the remote control should function again.
Control buttons do not operate	<ul style="list-style-type: none">● Disconnect the power cord and wait for a few seconds. Then re-plug the power cord and turn on the unit again.
Screen puts itself in stand-by mode as external device or PC goes in sleeping mode.	<ul style="list-style-type: none">● Change the energy settings/sleeping-mode of the external device or PC.
Fog appear on the screen	<ul style="list-style-type: none">● For the safety of screens, adding stalinite out of the screens. It is need to keep certain space between two layers for reserving air passages generate cross-ventilation and for insuring heat dissipation. Fog mainly comes from the temperature difference between the screen and the external. Moisture streaks congeal when hot air meets the low temperature glass surface The fog does not impact the normal use and it disappears after several-hour usage,

Note: If your problem is not solved, turn off your unit and then on again.

Cautions: Never attempt to repair a defective Screen yourself.

SPECIFICATIONS

Model No.	PM-TS65-LIV
Visible screen size	65inches(diagonal)
Power Source	100-240V~60Hz
Current (with PD)	2.8A
Power Consumption (with PD)	280 W
Standby condition *	≤ 0.5 W
Number of pixels (Display panel)	3840×2160
Dimensions (W×H×D) (Unit: mm)	1490.1mm x 878.1m x 86mm
Weight	43 kg Net
Operating conditions	Operating temperature: 5°C - 35°C, Storage temperature: -15°C - 45°C, Storage humidity: 10% - 80% Operating humidity: 20 % - 80 % (no moisture condensation), Atmospheric pressure: 86kPa ~ 106kPa
Connection terminals of the Screen	
PC IN	1
HDMI Input	2
HDMI OUT	1
DP Input	1
USB	4
USB C (Type C)	3
LAN	2
RS-232C	1
S/PDIF OUT	1
TOUCH OUT	2
EARPHONE	1

Notes:

1. Design and specifications are subject to change without notice.
 2. Weight and dimensions shown are approximate.
 3. Specifications and external appearance may be changed for the sake of improvement.
- * Due to different standby conditions, the standby power consumption of some models could be higher than 0.5W.